

Title		
Size	Number	Revision
A4		
Date:	2019/12/5	Sheet of
File:	D:\Workspace\...\Debugger.SchDoc	Drawn By:

U1A

EXMC_A23/PE2	1	EXMC_A23
EXMC_A19/PE3	2	EXMC_A19
EXMC_A20/PE4	3	EXMC_A20
EXMC_A21/PE5	4	EXMC_A21
EXMC_A22/PE6	5	EXMC_A22
VBAT	6	VBAT
TAMPER-RTC/PC13	7	PC13
OSC32IN/PC14	8	PC14/OSC32
OSC32OUT/PC15	9	PC15/OSC32
VSS_5	10	GND
VDD_5	11	3V3
OSCIN/PD0	12	PD0/OSC
OSCOUT/PD1	13	PD1/OSC
NRST	14	NRST
ADC1_IN10/PC0	15	PC0
ADC1_IN11/PC1	16	PC1
ADC1_IN12/PC2	17	PC2
ADC1_IN13/PC3	18	PC3
VSSA	19	GND
VREF-	20	GND
VREF+	21	GND
VDDA	22	3V3
WKUP/USART1_CTS/ADC1_IN0/TIMER1_CH0_ETI/PA0	23	WKUP
USART1_RTS/ADC1_IN1/TIMER1_CH1/TIMER4_CH1/PA1	24	LED_G
USART1_TX/ADC1_IN2/TIMER1_CH2/TIMER4_CH2/PA2	25	LED_R

GD32VF103V

U1B

USART1_RX/ADC1_IN3/TIMER1_CH3/TIMER4_CH3/PA3	26	LED_B
VSS_4	27	GND
VDD_4	28	3V3
SPI0_NSS/USART1_CK/ADC1_IN4/DAC_OUT0/PA4	29	PA4
SPI0_SCK/ADC1_IN5/DAC_OUT1/PA5	30	PA5
SPI0_MISO/ADC1_IN6/TIMER2_CH0/PA6	31	PA6
SPI0_MOSI/ADC1_IN7/TIMER2_CH1/PA7	32	PA7
ADC1_IN14/PC4	33	PC4
ADC1_IN15/PC5	34	PC5
ADC1_IN8/TIMER2_CH2/PB0	35	PB0
ADC1_IN9/TIMER2_CH3/PB1	36	PB1
BOOT1/PB2	37	PB2/BOOT1
EXMC_D4/PE7	38	EXMC_D4
EXMC_D5/PE8	39	EXMC_D5
EXMC_D6/PE9	40	EXMC_D6
EXMC_D7/PE10	41	EXMC_D7
EXMC_D8/PE11	42	EXMC_D8
EXMC_D9/PE12	43	EXMC_D9
EXMC_D10/PE13	44	EXMC_D10
EXMC_D11/PE14	45	EXMC_D11
EXMC_D12/PE15	46	EXMC_D12
I2C1_SCL/USART2_TX/PB10	47	PB10/SCL
I2C1_SDA/USART2_RX/PB11	48	PB11/SDA
VSS_1	49	GND
VDD_1	50	3V3

GD32VF103V

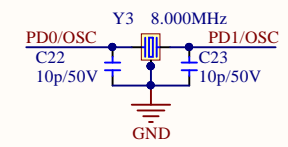
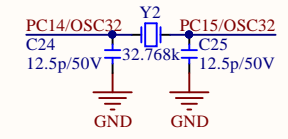

U1C

SPI1_NSS/I2C1_SMBA/USART2_CK/TIMER0_BRKIN/I2S1_WS/CAN1_RX/PB12	51	SD_CS
SPI1_SCK/USART2_CTS/TIMER0_CH0_ON/I2S1_CK/CAN1_TX/PB13	52	SD_SCLK
SPI1_MISO/USART2_RTS/TIMER0_CH1_ON/PB14	53	SD_MISO
SPI1_MOSI/TIMER0_CH2_ON/I2S1_SD/PB15	54	SD_MOSI
EXMC_D13/PD8	55	EXMC_D13
EXMC_D14/PD9	56	EXMC_D14
EXMC_D15/PD10	57	EXMC_D15
EXMC_A16/PD11	58	EXMC_A16
EXMC_A17/PD12	59	EXMC_A17
EXMC_A18/PD13	60	EXMC_A18
EXMC_D0/PD14	61	EXMC_D0
EXMC_D1/PD15	62	EXMC_D1
I2S1_MCK/PC6	63	PC6
I2S2_MCK/PC7	64	PC7
PC8	65	PC8
PC9	66	PC9
USART0_CK/TIMER0_CH0/CK_OUT0/USBFS_SOF/PA8	67	PA8
USART0_TX/TIMER0_CH1/USBFS_VBUS/PA9	68	USB_VBUS
USART0_RX/TIMER0_CH2/USBFS_ID/PA10	69	USB_ID
USART0_CTS/CAN0_RX/USBFS_DM/TIMER0_CH3/PA11	70	USB_DN
USART0_RTS/USBFS_DP/CAN0_TX/TIMER0_ETI/PA12	71	USB_DP
JTMS	72	JTAG_TMS
NC	73	
VSS_2	74	GND
VDD_2	75	3V3

GD32VF103V

U1D

JTCK	76	JTAG_TCK
SPI2_NSS/I2S2_WS/JTD1	77	JTAG_TDI
USART3_TX/PC10	78	PC10
USART3_RX/PC11	79	PC11
UART4_TX/PC12	80	UART_TX
EXMC_D2/PD0	81	EXMC_D2
EXMC_D3/PD1	82	EXMC_D3
TIMER2_ETI/UART4_RX/PD2	83	UART_RX
PD3	84	VBUS_OE#
EXMC_NOE/PD4	85	EXMC_NOE
EXMC_NWE/PD5	86	EXMC_NWE
EXMC_NWAIT/PD6	87	EXMC_NWAIT
EXMC_NE0/PD7	88	EXMC_NE0
SPI2_SCK/I2S2_CK/JTD0	89	JTAG_TDO
SPI2_MISO/NJTRST	90	PB4/NJTRST
I2C0_SMBA/SPI2_MOSI/I2S2_SD/PB5	91	PB5
I2C0_SCL/TIMER3_CH0/PB6	92	PB6
I2C0_SDA/TIMER3_CH1/EXMC_NADV/PB7	93	EXMC_NADV
BOOT0	94	BOOT0
TIMER3_CH2/PB8	95	PB8
TIMER3_CH3/PB9	96	PB9
TIMER3_ETI/EXMC_NBL0/PE0	97	EXMC_NBL0
EXMC_NBL1/PE1	98	EXMC_NBL1
VSS_3	99	GND
VDD_3	100	3V3

GD32VF103V

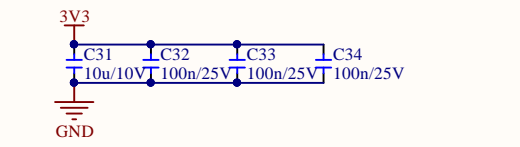
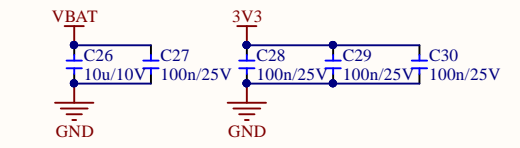
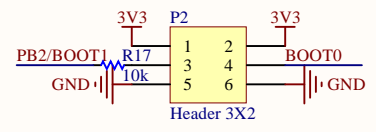

Title		
Size	Number	Revision
A4		
Date:	2019/12/5	Sheet of
File:	D:\Workspace\...\MCU.SchDoc	Drawn By:

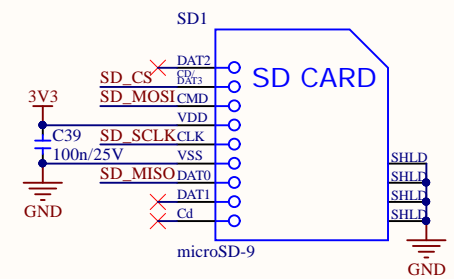
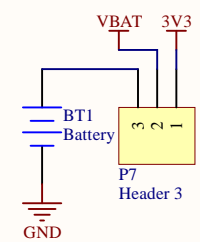
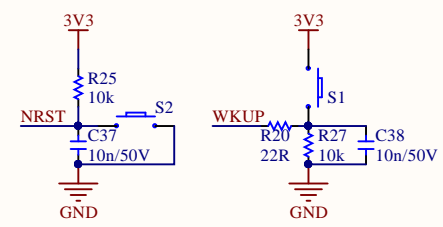
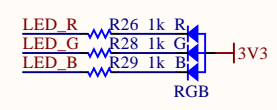
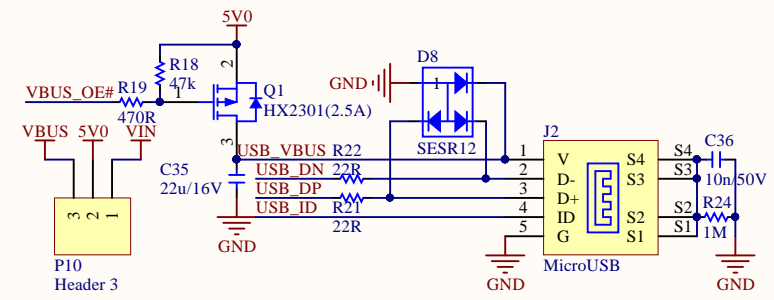
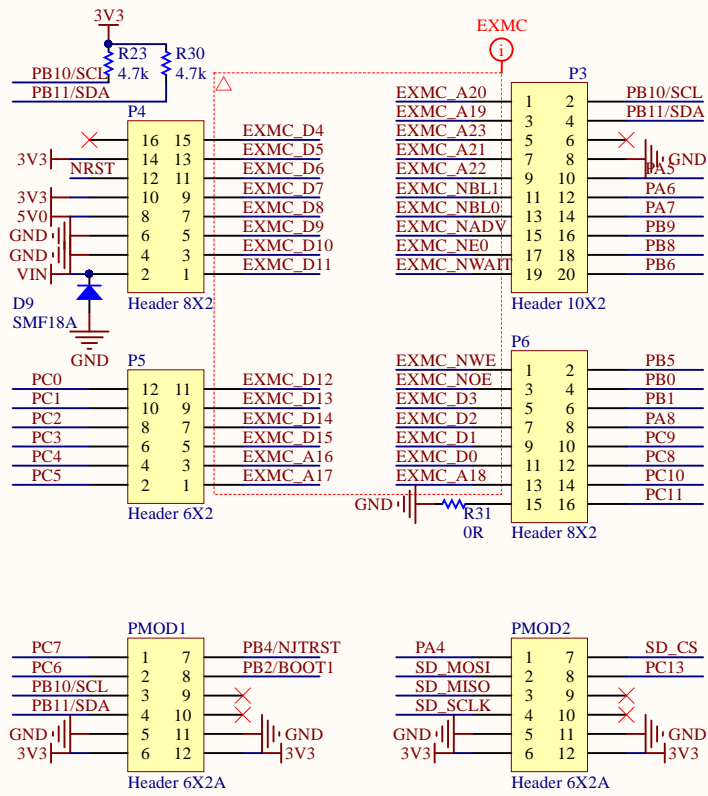

Title		
Size	Number	Revision
A4		
Date:	2019/12/5	Sheet of
File:	D:\Workspace\...\Peripherals.SchDoc	Drawn By:

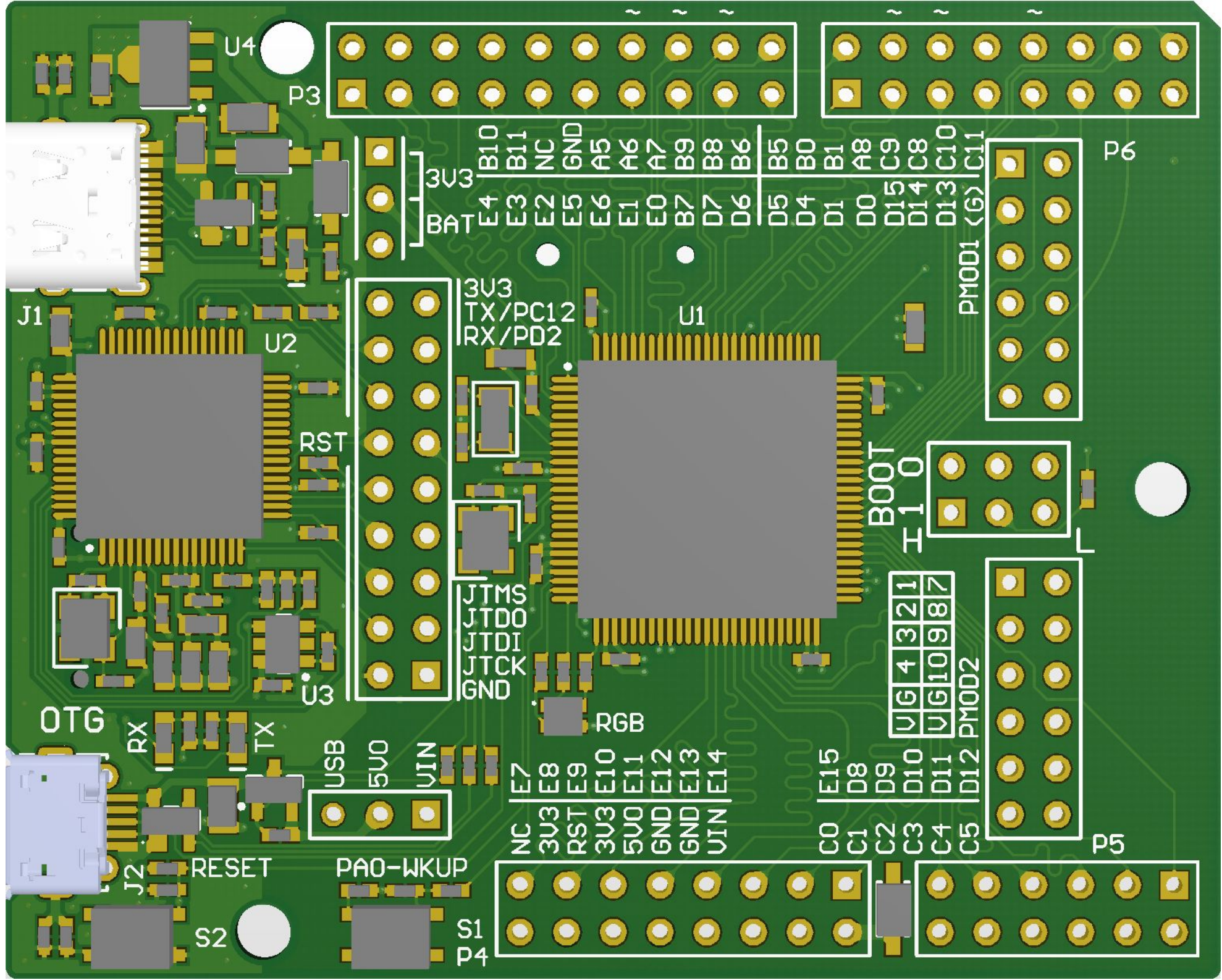

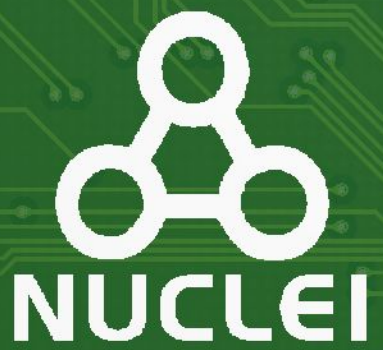

RV-STAR
2019.11-V1.0
riscv-mcu.com

R31

R23

R30

C39

